

Suter/ohlhorst

Modular Loudspeaker Systems

Manual

revision 22

System 515

System 515/9

System 515/99

System 519

System 519/9

Signalprozessor 4.8

NetControl



READ THIS FIRST!

DO NOT HOT PLUG THE SPEAKERS!

- Please make sure all amps are configured for the mains voltage of your country (e.g. 230V, 115V).
- To avoid damaging the speakers and voiding your warranty you have to ensure the following speaker connection sequence:
 1. Connect all XLR cables (1-6)
 2. Connect all power cables

Disconnection of the cables needs to be done in reversed order.

Never connect or disconnect a XLR cable of an already powered amp since this might damage the speakers! (*)

- It is strongly recommended to not switch the loudspeaker presets during high listening volumes.

() The reason for that is, because we want to have as few parts in the audio chain as possible to ensure maximum transparency. Due to that, each of our speaker chassis is directly connected to the amp.*

Content

1. Introduction	6
2. System Setup	7
2.1 Input Connection	7
2.1.1 Analog connection	7
2.1.2 Digital connection via AES/EBU	8
2.2 Output Connection	9
2.2.1 System 515	9
2.2.2 System 519	10
2.2.3 System 515/9	11
2.2.4 System 519/9	12
2.2.5 System 515/99	13
3. Signalprozessor	14
3.1 Overview	14
3.1.1 Front view	14
3.1.2 Rear view	14
3.1.3 Bar LED Display	15
3.1.4 Display and controls	15
3.2 Main Menu	15
3.2.1 Available Operations in the main menu	16
3.3 Load preset 'LOAD PRESET'	16
3.4 Save preset 'STORE PRESET'	16
3.4.1 Edit preset name	17
3.5 Mute	17
3.6 Menu navigation	17
3.6.1 Channel Settings	17
3.6.2 Select Input	18
3.6.3 Info	18
3.6.4 AES-Mode	18

3.6.5	EQ Settings	19
3.6.6	Outsum	19
3.6.7	Set IP-Address	20
3.6.8	Special Functions.....	20
3.7	Diagrams.....	21
3.7.1	Audio routing	21
4.	NetControl Software.....	22
4.1	Setup of Signalprozessor IP Address	22
4.2	NetControl Interface	24
4.2.1	Scan	24
4.2.2	Type in of IP Address.....	24
4.2.3	Main Window.....	25
4.2.4	IN Input Window	26
4.2.5	IIR Input Filter window.....	26
4.2.6	Output window	27
4.2.7	Limiter Window.....	28
4.2.8	Presets Window	29
4.2.9	Loading and Saving Presets.....	29
5.	Specifications	31
5.1	Speaker Models	31
5.1.1	Dimensions and Weight	31
5.2	Amplification	31
5.2.1	Specifications	31
5.3	Signalprozessor.....	32
5.3.1	Audio	32
5.3.2	DSP	32
5.3.3	Display.....	32
5.3.4	Network.....	32
5.3.5	Dimensions and Weight	33
6.	Warranty.....	34

1. Introduction

The suter/ohlhorst system is a modular speaker system. It has been developed by the two engineers Dan Suter (echochamber / Switzerland) and Jan Ohlhorst (finemastering / Germany). Our approach was to listen and work with as much as possible different speaker chassis, speaker chassis combinations in various cabinets (closed & ported) with different crossovers & settings in various rooms. Additionally acoustical measurements have been performed for understanding and verification.

The system is DSP-based which provides the possibility to tune it to the room and listeners taste. It is also modular and can be easily extended with additional ways.

2. System Setup

2.1 Input Connection

The input of the Signalprozessor can be connected as analog (left/right) or digital audio.

2.1.1 Analog connection

Connect the XLR output cable for left channel to input 1 and for right channel to input 2 of the Signalprozessor as shown in the figure below.

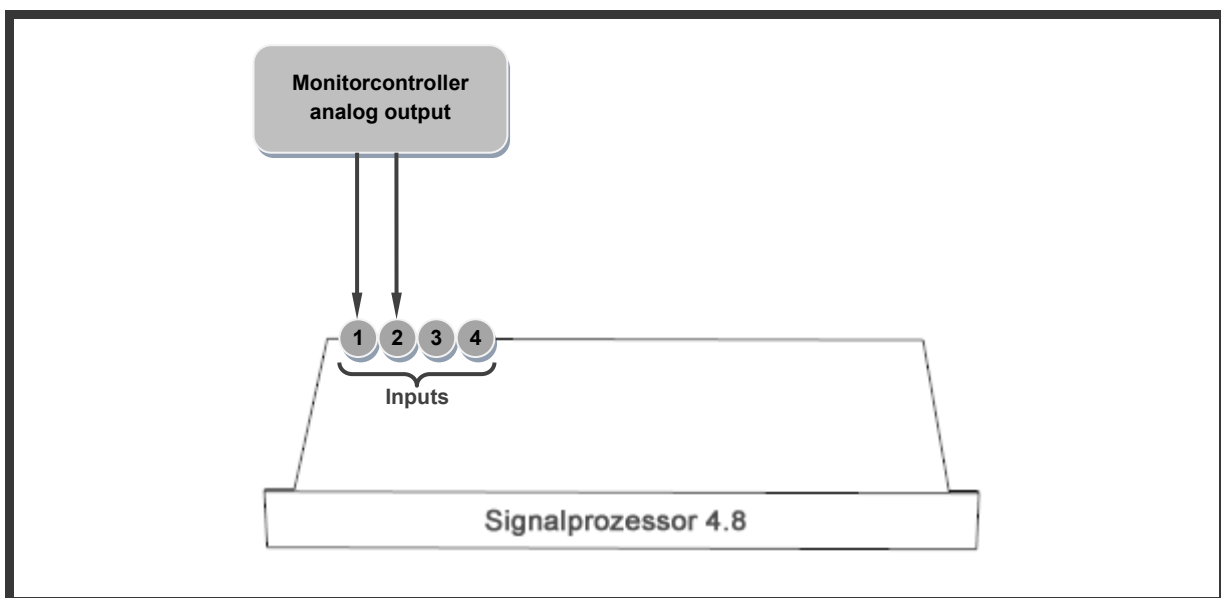

2.1.2 Digital connection via AES/EBU

The Signalprozessors digital input accepts digital Signals in the AES/EBU format (110ohm). Connect the AES XLR cable of your digital Monitor-/Volumecontroller to the Input 2 of the Signalprozessor as shown in the figure below.

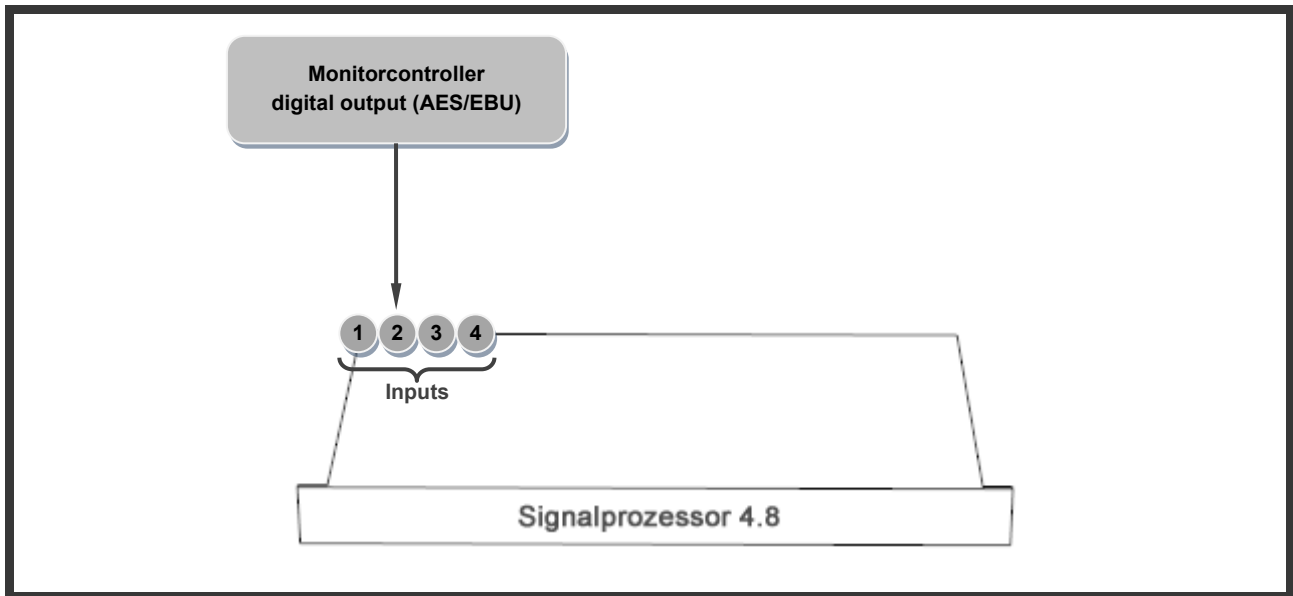

2.2 Output Connection

The amp(s) of each speaker model are directly connected to the Signalprozessors outputs. In the following the connection of the XLR cables to various Systems is shown.

⚠ Please make sure to connect your System as shown in the figures to avoid damaging the speakers.

2.2.1 System 515

Connect the XLR cables of the Signalprozessors analog outputs (1-4) to the corresponding inputs of the speaker amp. Make sure to connect as follows:

- Outputs 1/2 are always used for the HIGH speaker chassis (tweeter), where output 1 is for left and output 2 for the right speaker
- Outputs 3/4 are always used for the MID speaker chassis, where output 3 is for left and output 4 for the right speaker
- Outputs 5-8 are unused in that configuration

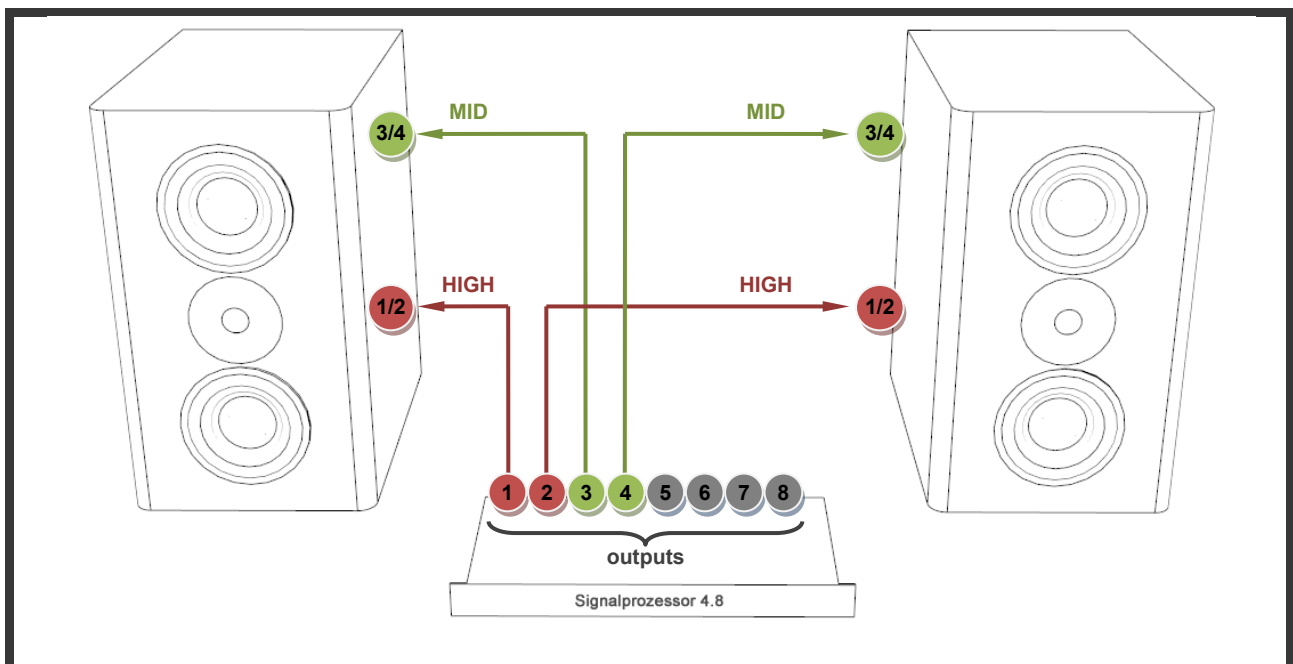

2.2.2 System 519

Connect the XLR cables of the Signalprozessors analog outputs (1-6) to the corresponding inputs of the speaker amp. Make sure to connect as follows:

- Outputs 1/2 are always used for the HIGH speaker chassis (tweeter), where output 1 is for left and output 2 for the right speaker
- Outputs 3/4 are always used for the MID speaker chassis, where output 3 is for left and output 4 for the right speaker
- Outputs 5/6 are always used for the LOW speakers chassis (bass chassis), where output 5 is for left and output 6 for the right speaker
- Outputs 7/8 are unused in that configuration

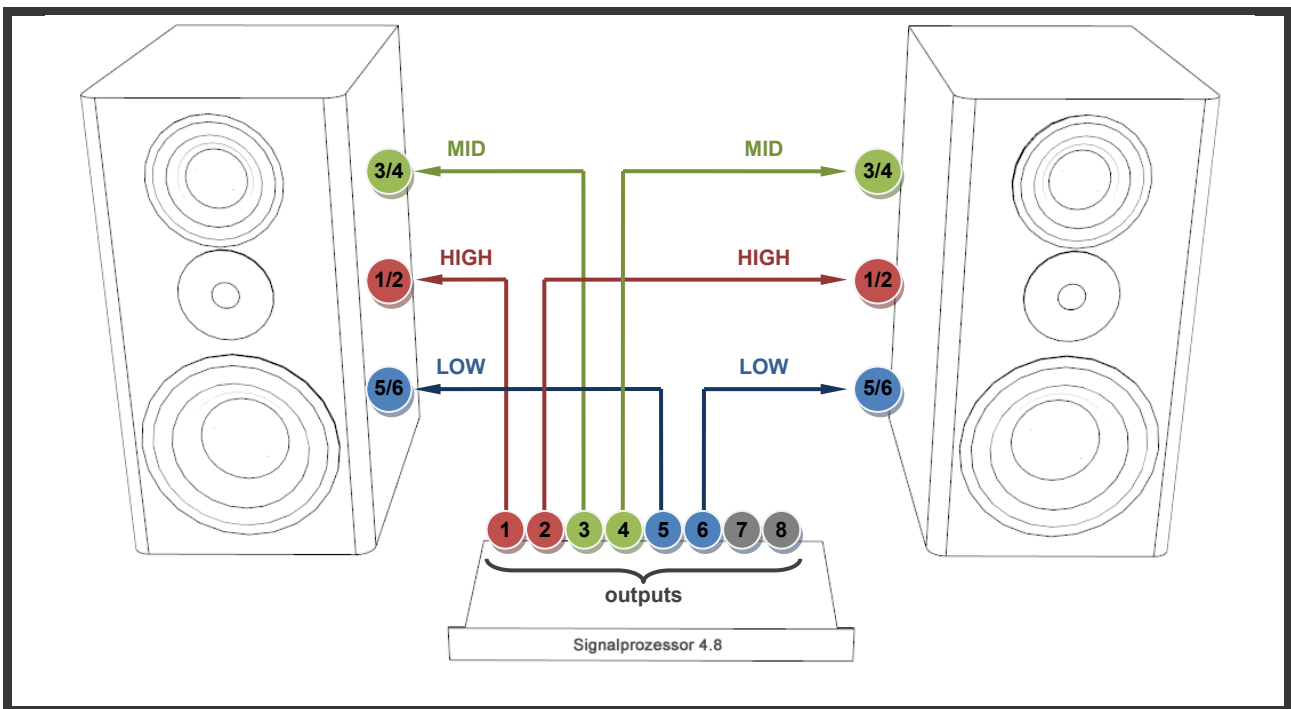

2.2.3 System 515/9

Connect the XLR cables of the Signalprozessors analog outputs (1-6) to the corresponding inputs of the speaker amp. Make sure to connect as follows:

- Outputs 1/2 are always used for the HIGH speaker chassis (tweeter), where output 1 is for left and output 2 for the right speaker
- Outputs 3/4 are always used for the MID speaker chassis, where output 3 is for left and output 4 for the right speaker
- Outputs 5/6 are always used for the LOW speakers chassis (bass chassis), where output 5 is for left and output 6 for the right speaker
- Outputs 7/8 are unused in that configuration

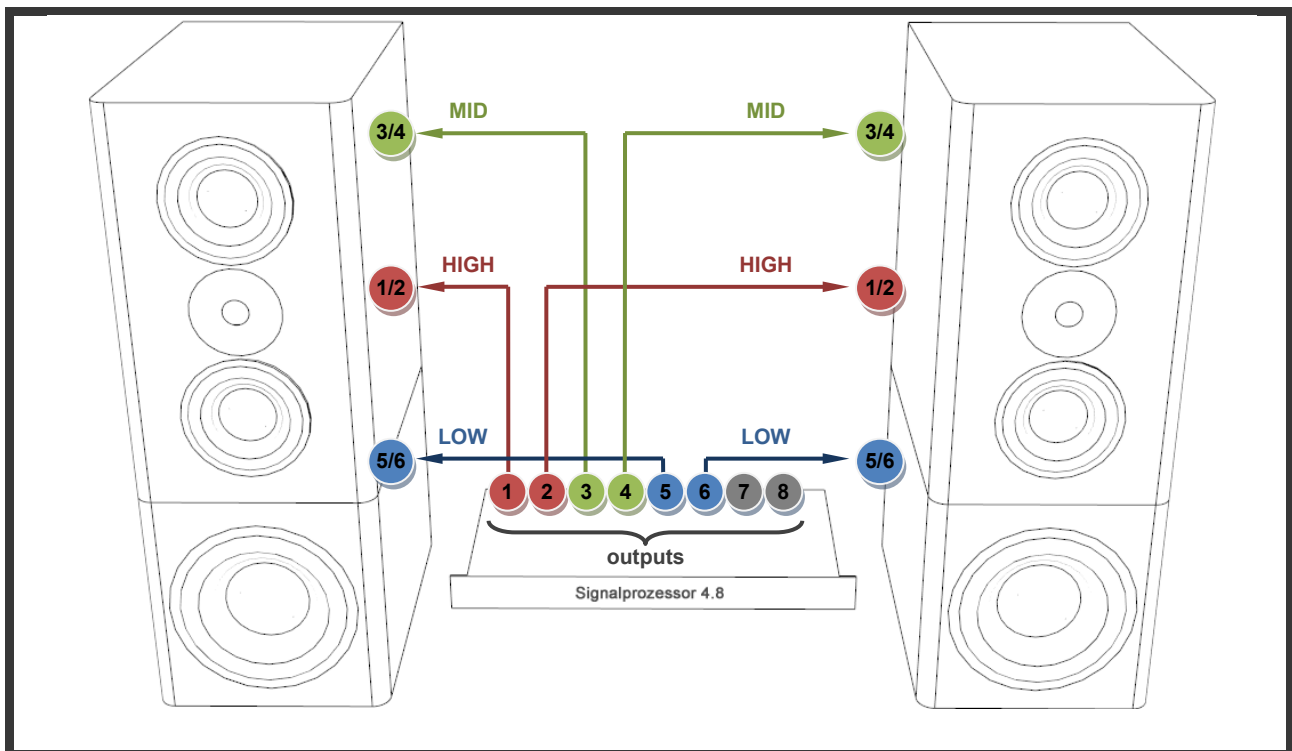

2.2.4 System 519/9

Connect the XLR cables of the Signalprozessors analog outputs (1-6) to the corresponding inputs of the speaker amp. Make sure to connect as follows:

- Outputs 1/2 are always used for the HIGH speaker chassis (tweeter), where output 1 is for left and output 2 for the right speaker
- Outputs 3/4 are always used for the MID speaker chassis, where output 3 is for left and output 4 for the right speaker
- Outputs 5/6 are always used for the LOW speakers chassis (bass chassis), where output 5 is for left and output 6 for the right speaker
Please use our XLR Y-cable to split the Signal of outputs 5/6
- Outputs 7/8 are unused in that configuration

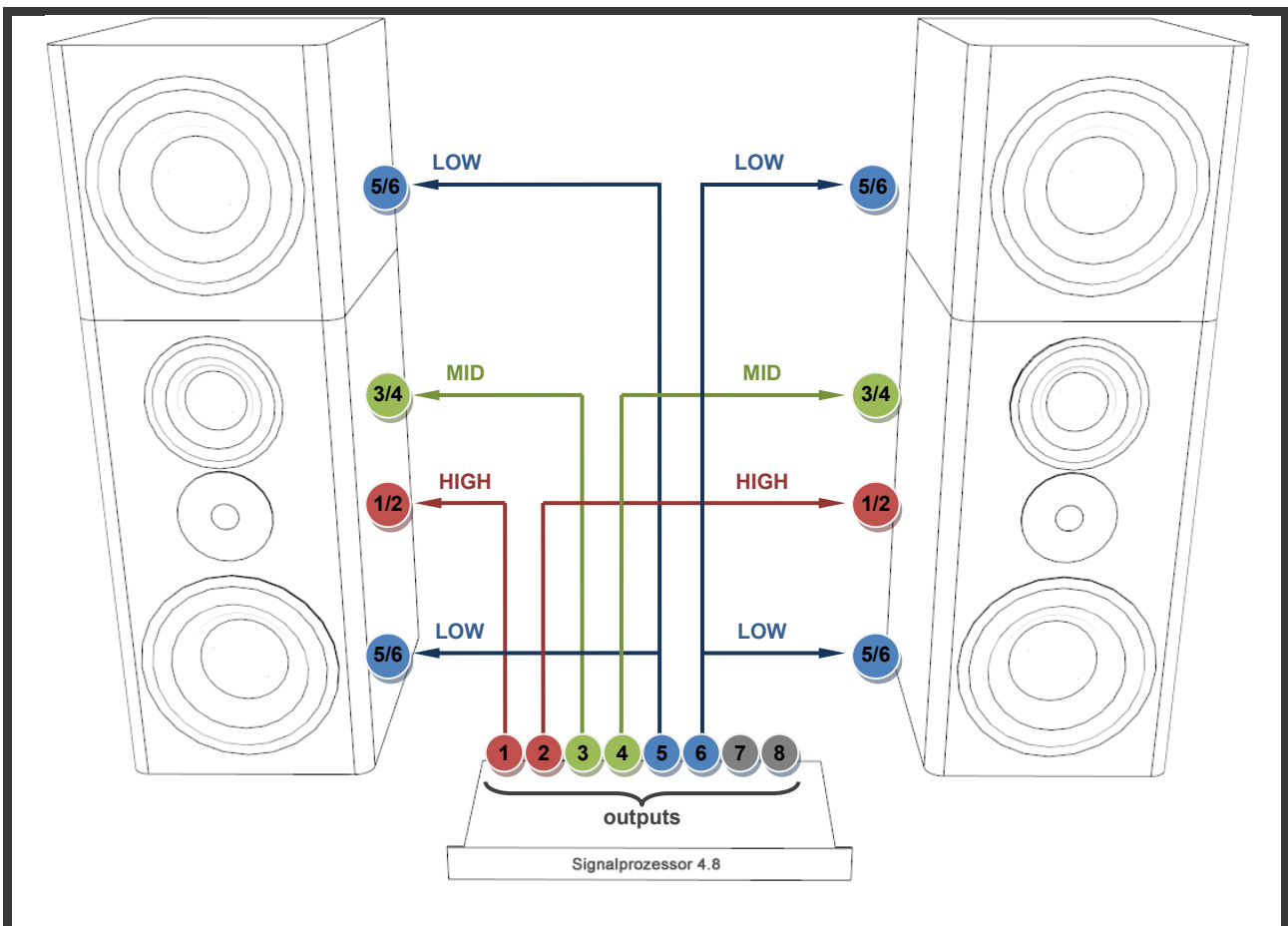

2.2.5 System 515/99

Connect the XLR cables of the Signalprozessors analog outputs (1-6) to the corresponding inputs of the speaker amp. Make sure to connect as follows:

- Outputs 1/2 are always used for the HIGH speaker chassis (tweeter), where output 1 is for left and output 2 for the right speaker
- Outputs 3/4 are always used for the MID speaker chassis, where output 3 is for left and output 4 for the right speaker
- Outputs 5/6 are always used for the LOW speakers chassis (bass chassis), where output 5 is for left and output 6 for the right speaker
Please use our XLR Y-cable to split the Signal of outputs 5/6
- Outputs 7/8 are unused in that configuration

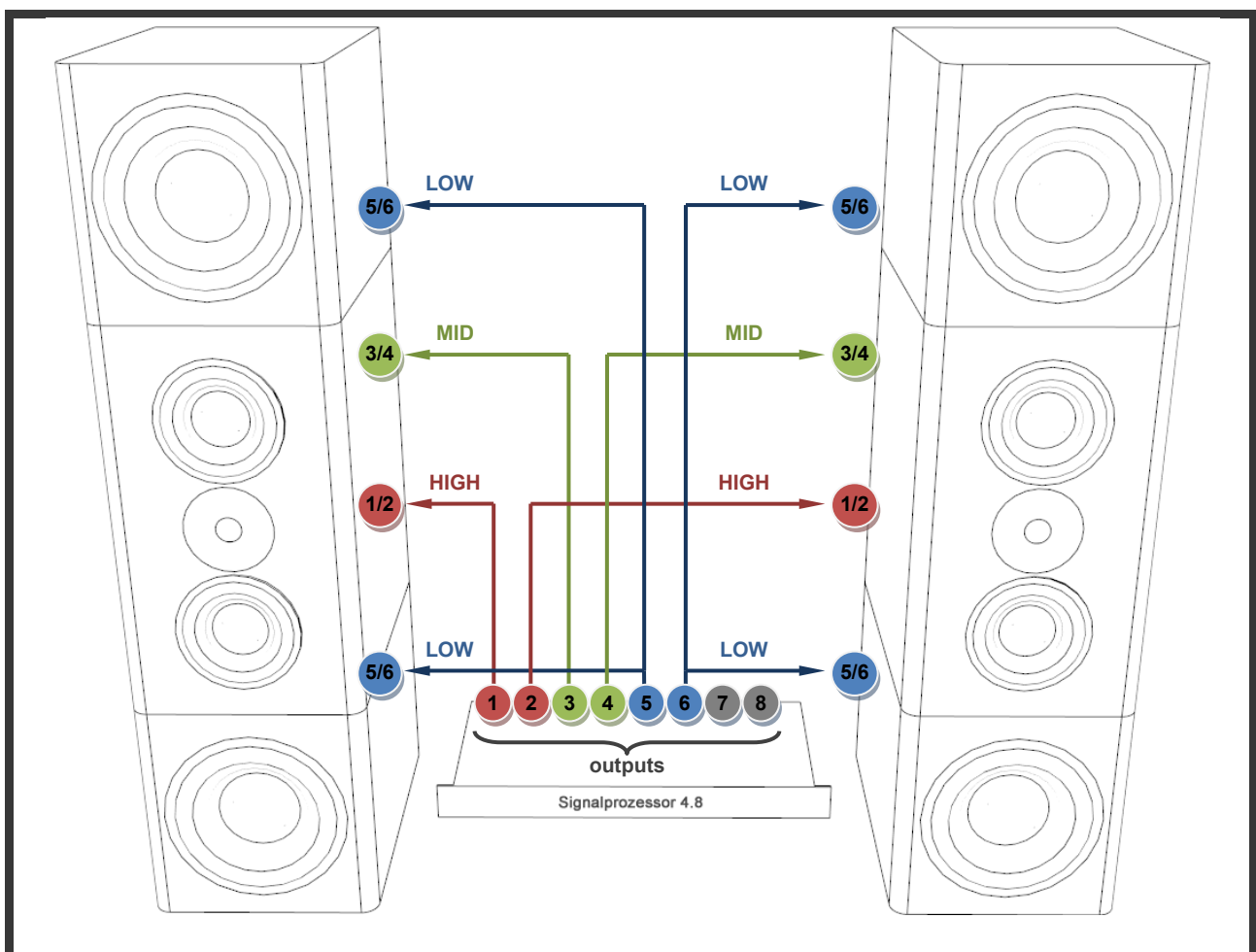

3. Signalprozessor

The Signalprozessor is the central control of the suter/ohlhorst loudspeaker systems. It implements the digital crossovers for the various system configurations including the driver adjustments. It is also used to fine-tune the system to the room and to the listeners taste.

3.1 Overview

3.1.1 Front view

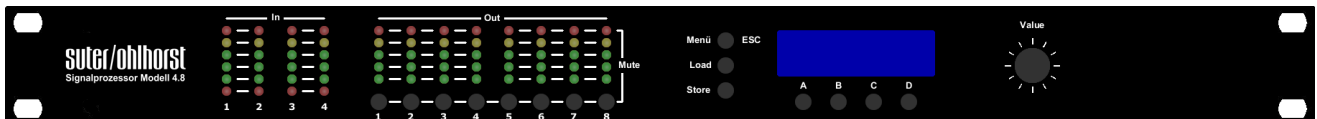

The Signalprozessor hardware controller gives you a nice overview of output levels, currently selected preset etc.

3.1.2 Rear view

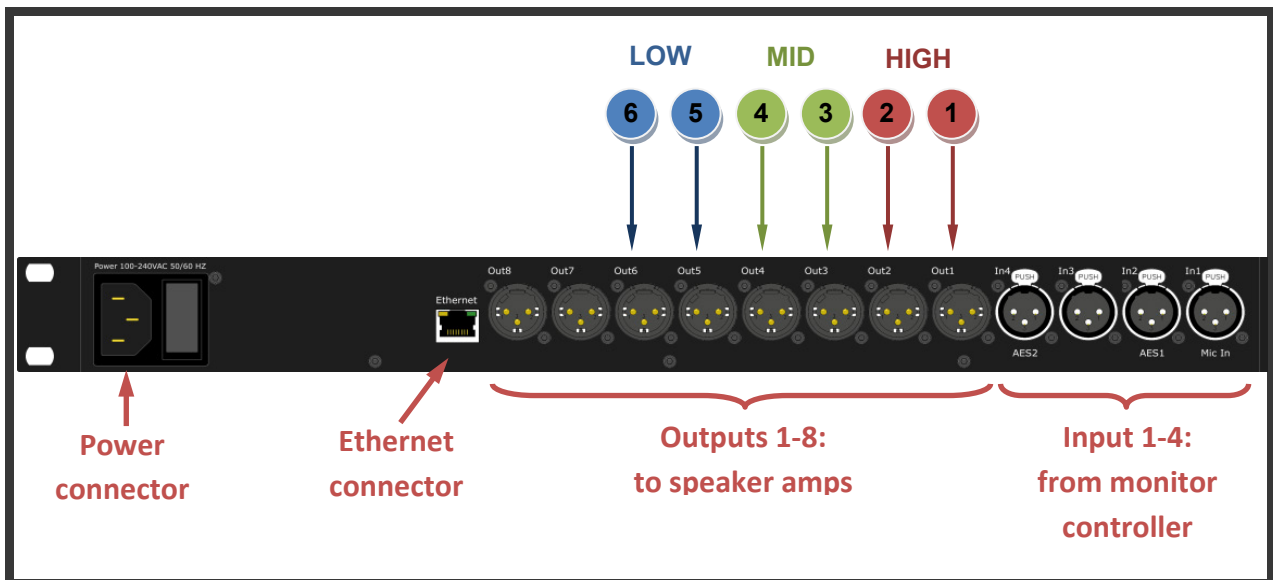

All cable connection is done on the rear side of the Signalprozessor. Beside the power connector, the already mentioned Ethernet connector is available. Furthermore you have XLR jackets for the outputs and inputs.

 Please note, that the power cable might have a securing. In that case you need to slide back the red plastic pin on the cable before pulling it out.

3.1.3 Bar LED Display

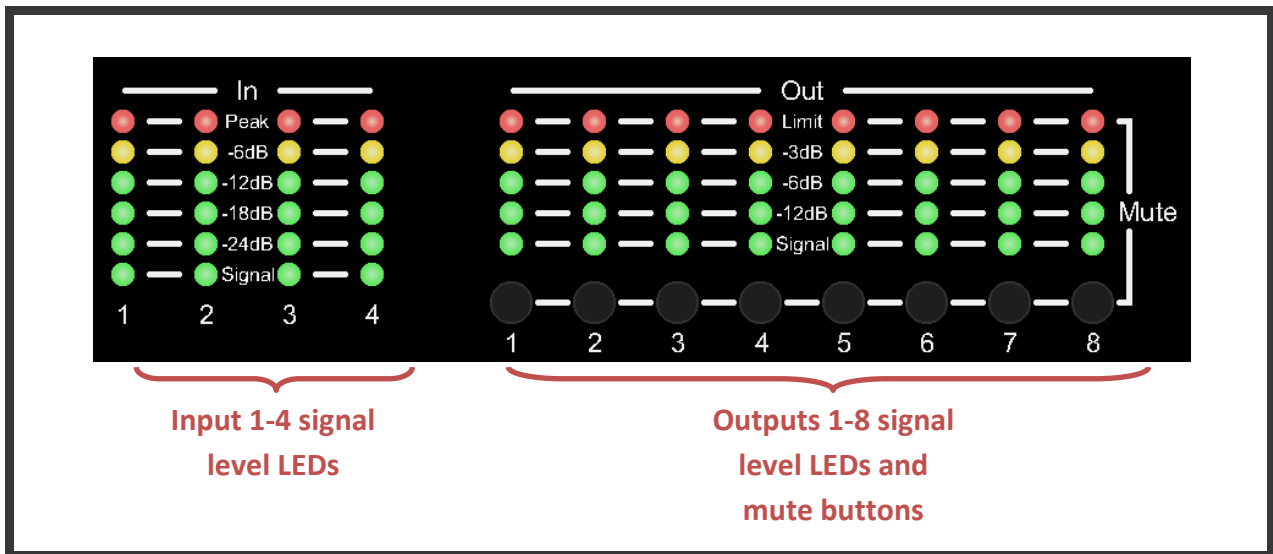

The Front Bar LED Display gives a good overview on the Signalprozessors input and output signal level. In the output section you can additionally mute each output by pressing the corresponding mute button.

3.1.4 Display and controls

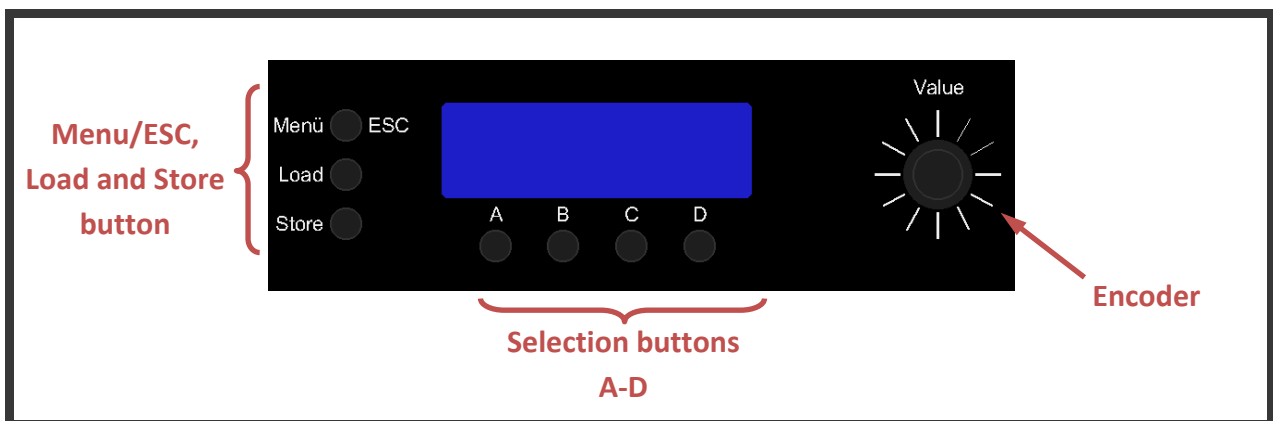

The Display typically shows the loaded preset. With the various buttons and the Encoder all settings can be done. Of course we highly recommend to use the NetControl software to make all adjustments as described in chapter 4.

3.2 Main Menu

In the main menu the device name, currently loaded preset and network information are displayed.

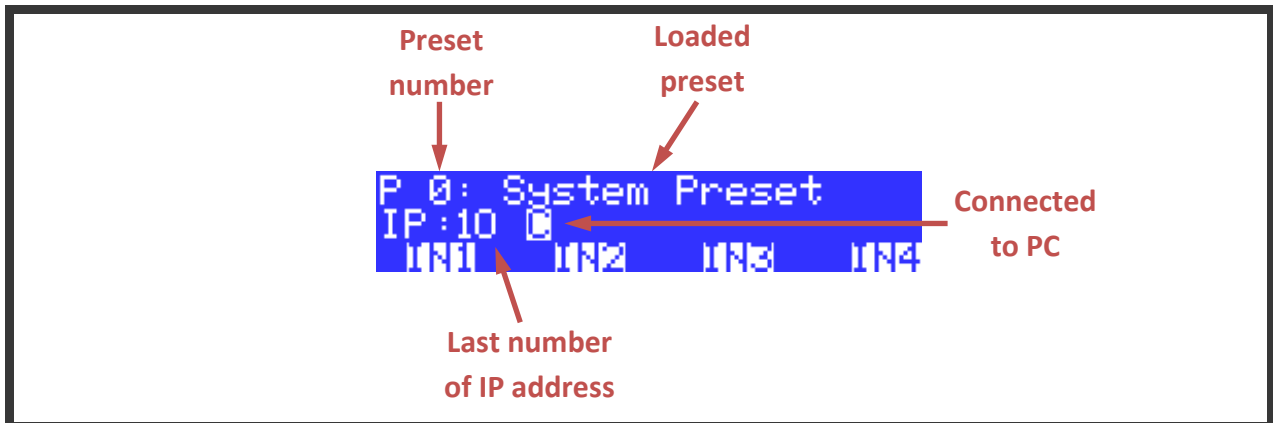

3.2.1 Available Operations in the main menu

Menu / ESC:	Switch to menu navigation
Load:	Open the menu 'LOAD-PRESET'. (see chapter 4)
Store:	Open the menu 'STORE-PRESET'. (see chapter 8)
A 'IN1':	Press and hold to see the routing and name for Input 1
B 'IN2':	Press and hold to see the routing and name for Input 2
C 'IN3':	Press and hold to see the routing and name for Input 3
C 'IN4':	Press and hold to see the routing and name for Input 4

3.3 Load preset 'LOAD PRESET'

Encoder:	Select preset
A 'LOAD':	Load preset
D 'EXIT':	Exit menu without modification
Menu/ESC:	Exit menu without modification

 ***It is strongly recommended to not switch the loudspeaker presets during high listening volumes.***

3.4 Save preset 'STORE PRESET'

Encoder:	Select memory (1 – 24)
A 'STORE':	Save preset with the current name in the selected memory
B 'EDIT':	Edit preset name
D 'EXIT':	Exit menu without modification
Menu/ESC:	Exit menu without modification

3.4.1 Edit preset name

Encoder:	Select number at the current cursor position
A '<-':	Move cursor left
B '->':	Move cursor right
C 'CLR':	Clear display
D 'STORE':	Save preset with the entered name in the previously selected memory
Menu/ESC:	Exit the menu without modification and return to storage space selection

3.5 Mute

Pressing and holding the keys “ESC/Menü”, “Load” or “Store” for a longer time will switch to one of the following mute menus. In the mute menus the keys A-D will mute or unmute the corresponding channel.

Mute menus:

Menu/ESC:	MUTE IN 1-4
Load:	MUTE OUT 1-4
Store:	MUTE OUT 5-8

It is also possible to mute or unmute the output channels with the keys located under the output bar-graph.

3.6 Menu navigation

Pressing the “Menu / ESC” key and turning the encoder selects between the following menus:

CHANNEL SETTINGS	Chapter 3.6.1
SELECT INPUT	Chapter 3.6.2
INFO	Chapter 3.6.3
AES-MODE	Chapter 3.6.4
EQ SETTINGS	Chapter 3.6.5
OUTSUM	Chapter 3.6.6
SET IP-ADDRESS	Chapter 3.6.7

3.6.1 Channel Settings

In the CHANNEL SETTINGS menu the following values can be set for each input or output channel:

Phase	0° or 180°
Delay	in 0,01 ms steps

Gain	in 0,1 dB steps
------	-----------------

Available operations in CHANNEL SETTINGS

A + Encoder:	Select channel for editing (IN 1–4 / OUT 1–8)
B + Encoder:	Adjust the Phase 0° / 180°
C + Encoder:	Adjust the channel delay in 0,01 ms steps.
D + Encoder:	Adjust the gain in 0,1 dB steps
Load / Store:	Copy 'n Paste the channel settings
Menu/ESC:	Back to main menu

Pressing the Encoder while turning sets the step size to 10

Copy & Paste

With the keys Load and Store the channel settings could be copied and pasted to another channel.

Proceed as follows:

- Adjust the selected channels as desired
- Press the 'Load' key
- Select the channel for the settings to be copied at
- Press the 'Store' key

The copied settings are now applied to the selected channel.

3.6.2 Select Input

This menu enables selecting between AES and analog inputs.

To change between the inputs press and hold the “A” key and turn the encoder.

3.6.3 Info

This menu page delivers following information:

- Device Type
- Device Name
- Serial-number
- Firmware-version

3.6.4 AES-Mode

On this page information about the connected AES signals is displayed:

- The sample-rate or “UNLOCK” if no AES signal is detected
- The AES format

3.6.5 EQ Settings

Here filter settings can be edited for each band available for the input and output channels.

A + Encoder:	Select channel for editing (IN 1-4 / OUT 1-8)
B + Encoder:	Select EQ band for editing - Inputs: EQ band 1-15 - Outputs: EQ band 1-10
C + Encoder:	Select the filter type.
D 'EDIT':	Opens the settings menu of the selected EQ band
Load / Store:	Copy 'n Paste of the channel settings
Menu/ESC:	Back to main menu

Pressing the Encoder while turning sets the step size to 10

Available filter types

The following filter type can be selected:

- OFF → no filter active
- Peak → Peak filter
- HP → High-Pass
- LP → Low-Pass
- H-Shelf → High-Shelf
- L-Shelf → Low-Shelf

Copy & Paste

To use the copy 'n paste for the EQ settings proceed as follows.

- Adjust the settings for the selected channel as desired
- Press the 'Load' key
- Select the channel for the settings to be copied at
- Press the 'Store' key

The copied settings are now applied to the selected channel.

3.6.6 Outsum

An individual input mix to each output channel can be assigned. To assign a mix use the following keys.

key A + Encoder:	Selecting the output channel to be edited (OUT 1-8)
key B:	Move cursor left
key C:	Move cursor right
key D:	Enable or disable input
Load / Store:	Copy 'n Paste of the input assignment (see chapter 7.1.2)
Menü/ESC:	Back to main menu

Pressing the Encoder while turning sets the step size to 10

Copy & Paste

To use the copy 'n paste for the outsum settings proceed as follows.

- Set the input assignment of the selected output as desired
- Press the 'Load' key
- Select the output for the settings to be copied at
- Press the 'Store' key

The copied settings are now applied to the selected channel.

3.6.7 Set IP-Address

The MAC address of the device is displayed and the IP address could be set.

A change to the IP address will not take effect until the device is rebooted. Please refer to section 4.1 to find out which IP address is appropriate in your case / for your network.

To edit the IP-Address use the following keys:

A + Encoder:	Setting of first IP-Octet
B + Encoder:	Setting of second IP-Octet
C + Encoder:	Setting of third IP-Octet
D + Encoder:	Setting of fourth IP-Octet
Load / Store:	without function
Menu/ESC:	Back to main view

Pressing the Encoder while turning sets the step size to 10

3.6.8 Special Functions

Display LOCK:	To lock the display press and hold the encoder for 3 seconds and press additionally the A key to lock the display controls. Press keys Menu/ESC or A to return to the main menu. If the display is locked pressing one of the display keys will show the Unlock menu. The mute keys under the output bar graph are still working
Display UNLOCK:	To unlock the display set the code to '12345' by turning the encoder and press the D 'SET'.
Clear Group Param:	To remove group parameters set by the PC software press and hold the encoder for 3 seconds and press additionally the B key.
Clear All Param:	To set all parameters to their default setting press and hold the encoder for 3 seconds and press additionally the C key.

3.7 Diagrams

3.7.1 Audio routing

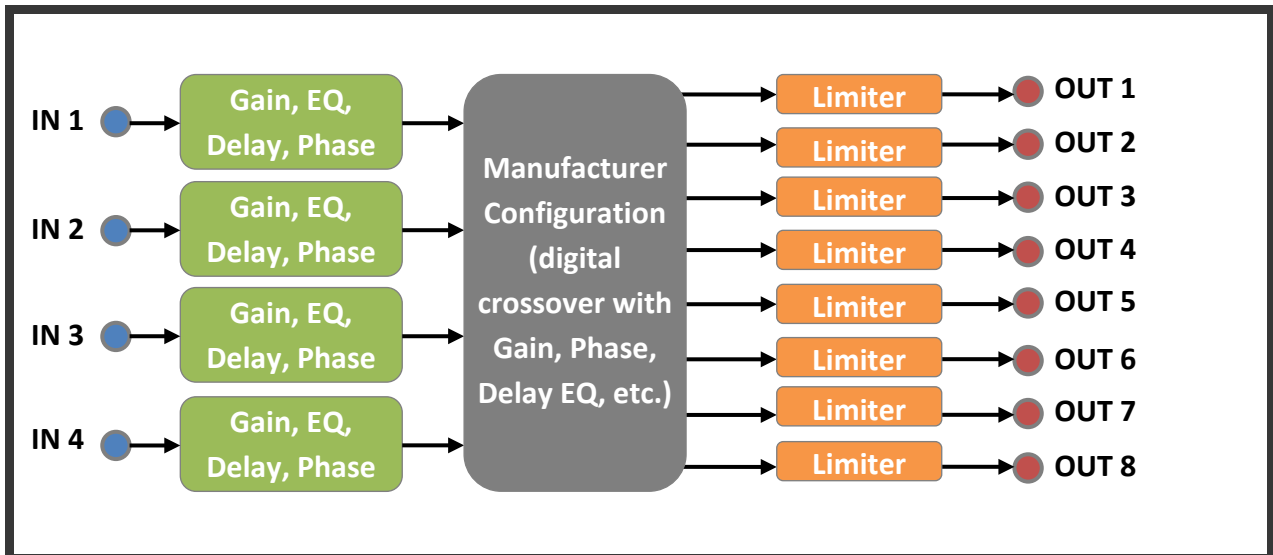

4. NetControl Software

Although most settings of the Signalprozessor can be done directly on the hardware unit, it is recommended to connect the unit to an Ethernet port of your PC or to the router/switch of your home network via the Ethernet cable and use the NetControl Windows software to make adjustments while having a much better overview.

4.1 Setup of Signalprozessor IP Address

In order to successfully connect the Signalprozessor a proper IP address for the unit needs to be set. The easiest way is to give the Signalprozessor a free IP address which belongs to the same home network as your PC. To find out in which home network your PC is, you can perform the following steps:

1. Open a command window by one of the following methods:

WINDOWS XP, Vista, 7

- a) From the start menu, enter "**CMD**" (without the quotes) in the search box and press enter.
- b) From the start menu, select "Run". Enter "**CMD**" in the "Open:" box, and click OK

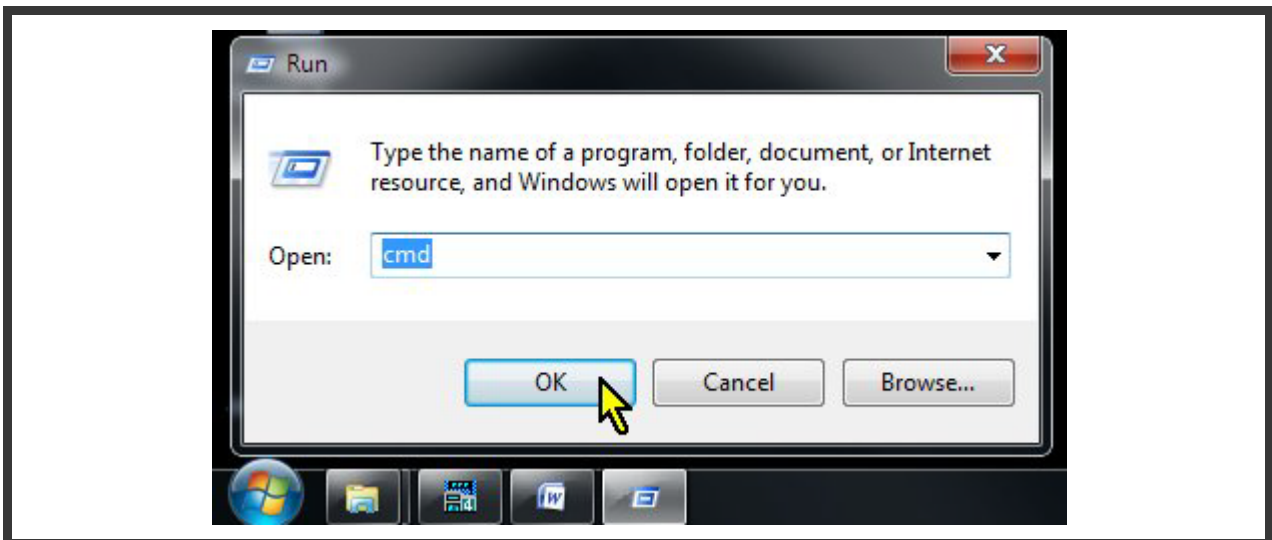

WINDOWS 8-10:

- a) Right click with your mouse on the Windows start menu icon and left click "**Command Prompt**" or "**Command Prompt (Admin)**"

- b) Left click with your mouse on the Windows start menu icon and type in "CMD" (without the quotes). The app "Command Prompt" should show up. Now just left click on it.

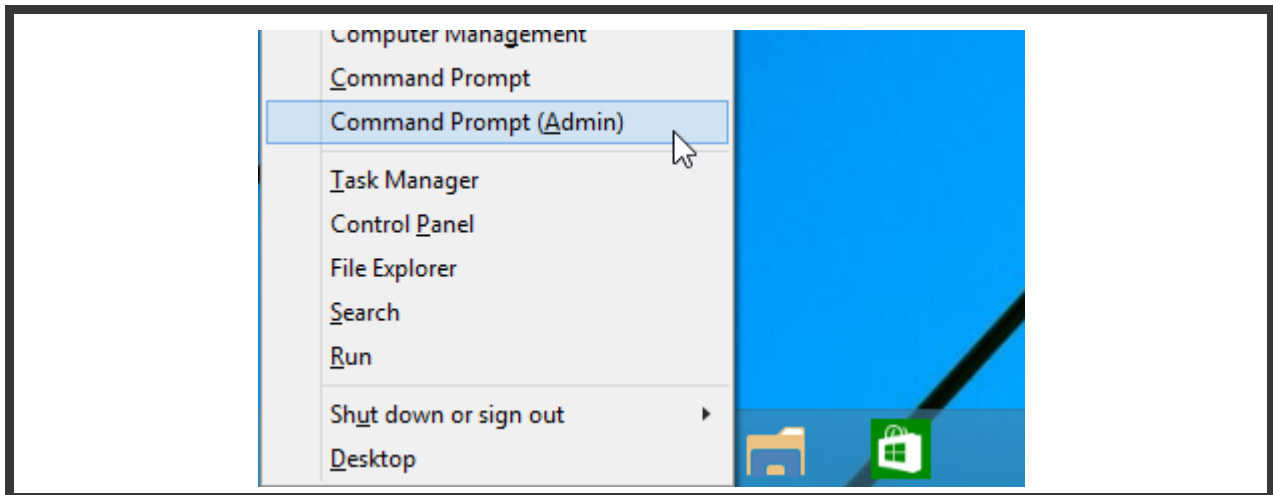

2. Type in: **ipconfig** and press enter
The following will show up (maybe you have to scroll up a bit):

```

C:\Users\DWard>ipconfig

Windows IP Configuration

Ethernet adapter Local Area Connection:

    Connection-specific DNS Suffix  . : gateway.2wire.net
    Link-local IPv6 Address . . . . . : fe80::b176:f789:cd3f:
    IPv4 Address. . . . . : 192.168.1.119
    Subnet Mask . . . . . : 255.255.255.0
    Default Gateway . . . . . : 192.168.1.254
  
```

Your IP address is underlined in red. Your home network in that case is: **192.168.1.xxx** and your computers last number here is 119. It is important to set the first 3 numbers of your Signalprozessors IP address to the same numbers as your home network and choose a different last number for the Signalprozessor, e.g. **99** (=192.168.2.99).

How to set the Signalprozessors IP address is explained in section 3.6.7

4.2 NetControl Interface

The NetControl Software doesn't need to be installed and is simply started by double clicking NetControl.exe.

4.2.1 Scan

The following window will show up. Here you can Rightclick on **Ethernet Network0** and select **Scan**

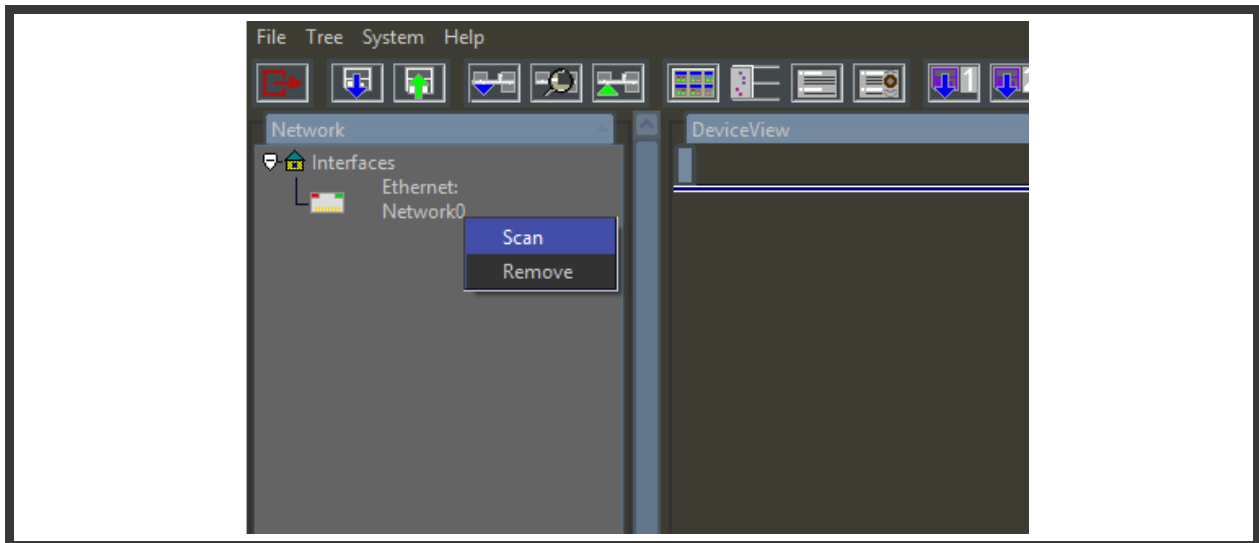

4.2.2 Type in of IP Address

In the following window you need to type in the IP Address of your Signalprozessor as shown below and click **connect**. Please refer to section 3.6.7 to find out the IP address.

 ***It is important to setup the Signalprozessor with an IP address of your home network, otherwise it may happen that NetControl cannot find the Signalprozessor. For further information please refer to section 4.1***

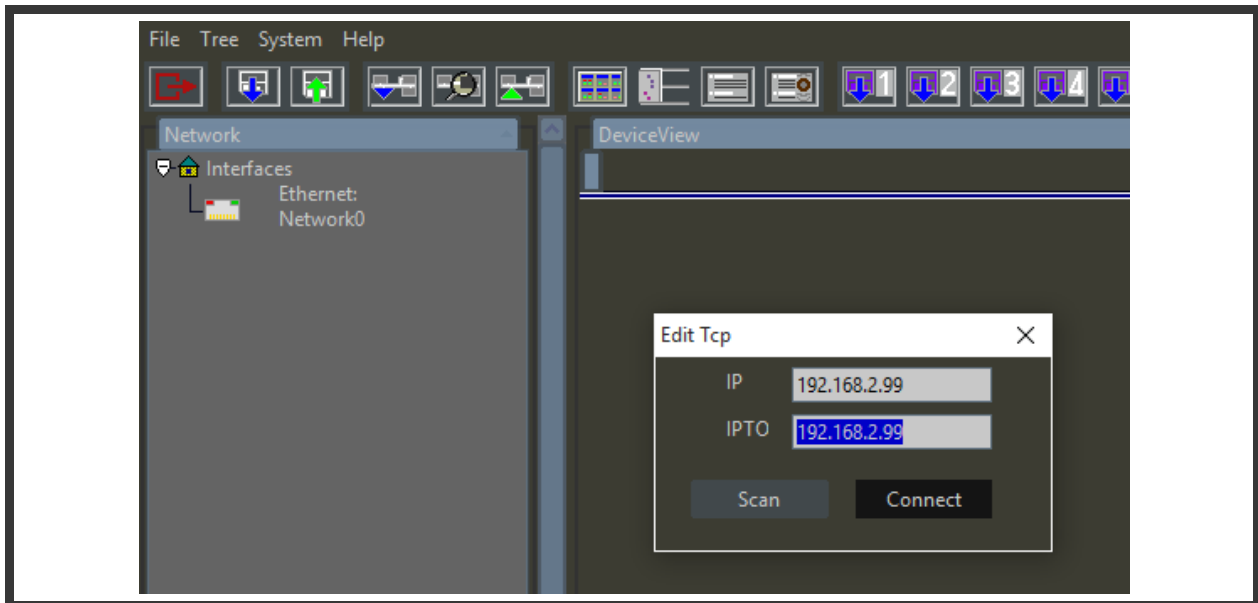

4.2.3 Main Window

If the connection was successful the main window will show up.

⚠ While the Signalprozessor is connected to NetControl no changes on the Hardware unit can be done.

- (1) "CO" indicates that the Signalprozessor is connected.
- (2) "Link" can be activated to link channel 1 & 2. Red=unlinked, Green=linked. It is recommended to link. In linked mode all changes of the IIR Input Filters on channel 1 are automatically transferred to channel 2.
- (3) This shows preset number (here "24") and preset name (here "515-9999")
- (4) Here the input mode can be switched between AES / Analog
- (5) In this section you can select a preset & load a preset or store the current preset

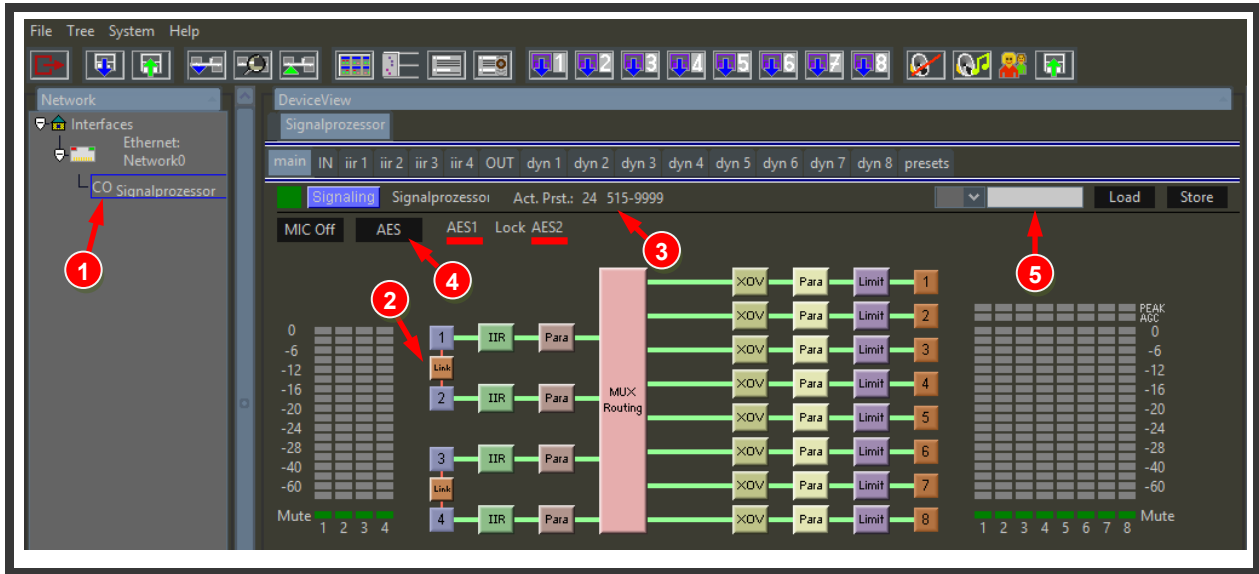

4.2.4 IN Input Window

In the input window tab, you can set input delay (which is typically not of interest) and input gain. The latter one is of interest if you would like to adjust the volume of the speaker system to your monitor controller, e.g. to calibrate a given volume controller position to a reference level.

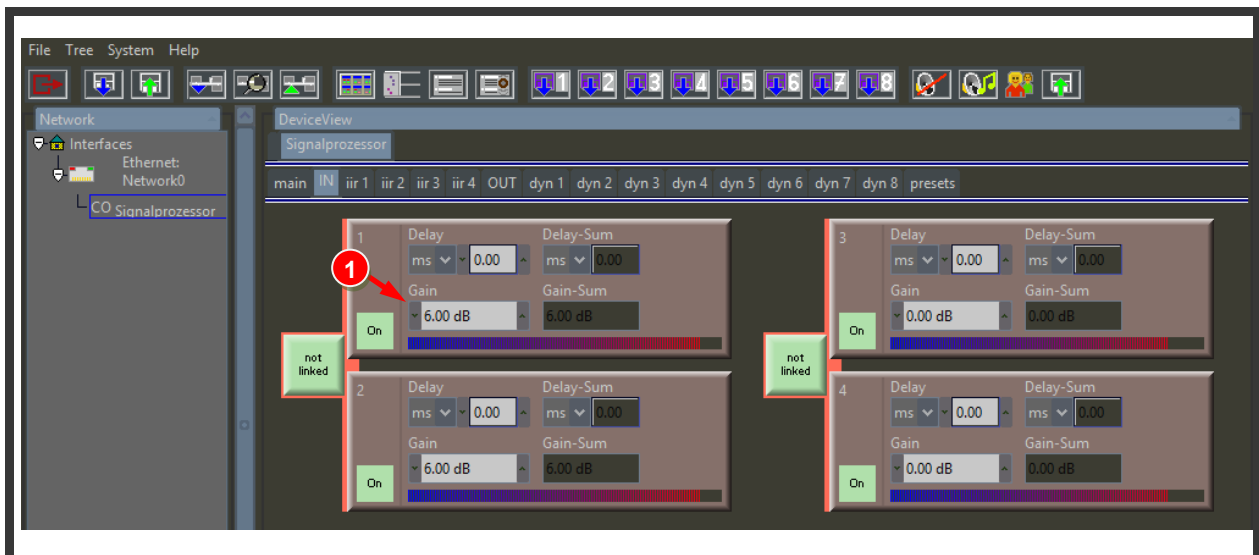

4.2.5 IIR Input Filter window

In the iir1 to iir4 tabs you have access to the 10 band full parametric IIR equalizer. Here you can adjust the systems frequency response to the response of your room, but also to your taste. It is recommended to perform adjustments jointly by professional room measurements, either by yourself or a trained acoustician.

! Make sure to always link input channels 1+2 as described in section 4.2.3 under (2).

- (1) Here you can select the view between input 1 (iir1) to input 4 (iir4)
- (2) Each of the 10 bands can set a filter shape (e.g. high/low shield, peak, etc.), the (center) frequency and the gain

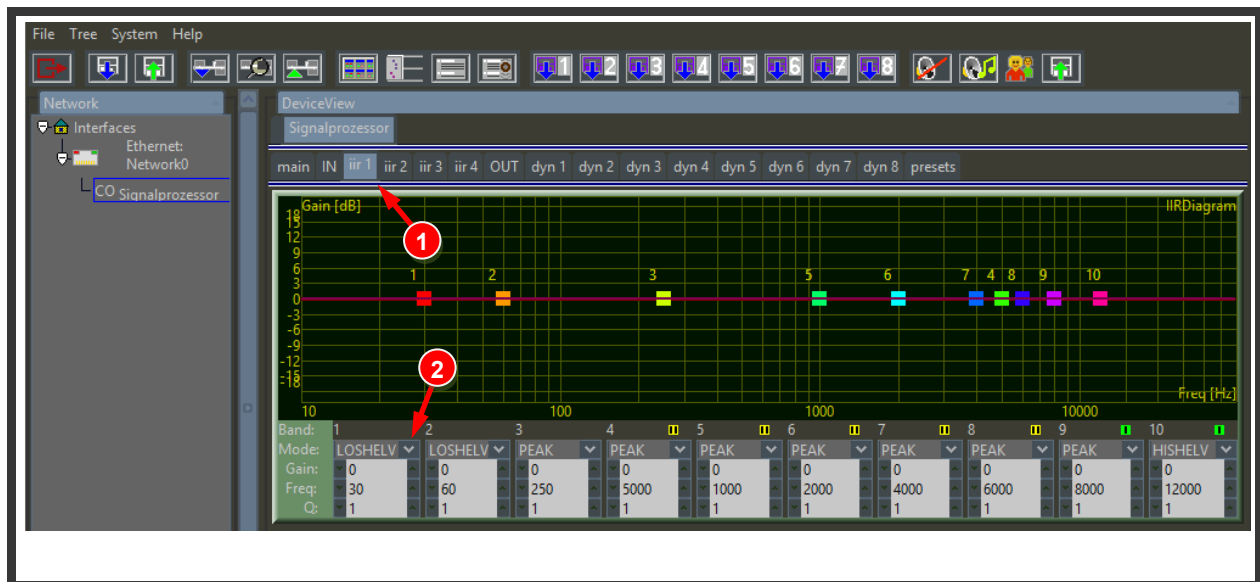

4.2.6 Output window

The output

- (1) Sets which the input channel is routed to this output channel (1-4 to 1-8). In this case input channel 1 (left) is routed to output channel 2 (left).
- (2) Sets the output Delay unit & value (it is not recommended to change that value)
- (3) Sets the output gain (here left high chassis)
- (4) Sets the output on/off
- (5) Shifts the phase (it is not recommended to change that value)

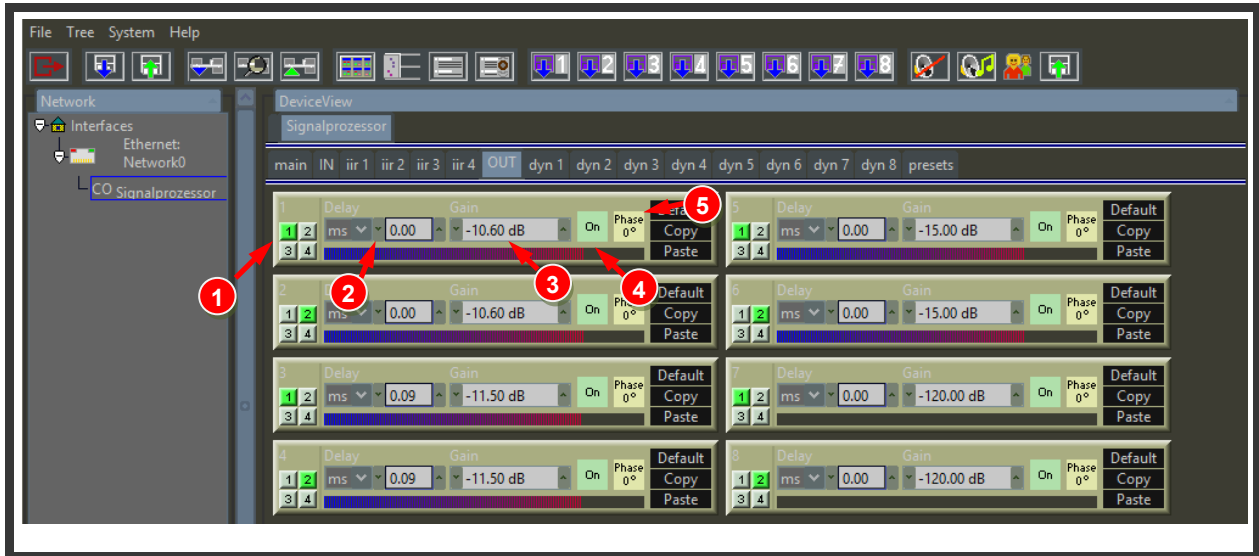

4.2.7 Limiter Window

- (1) Sets the output 1-8 limiter threshold, attack & release values. Since these parameters are also predefined, it is not recommended to remove the limiter setting (e.g. by setting threshold to 0dB). These parameters have been set to not only protect the system but also your ears.
- (2) Here you can go back or copy & paste settings from one output to the others.

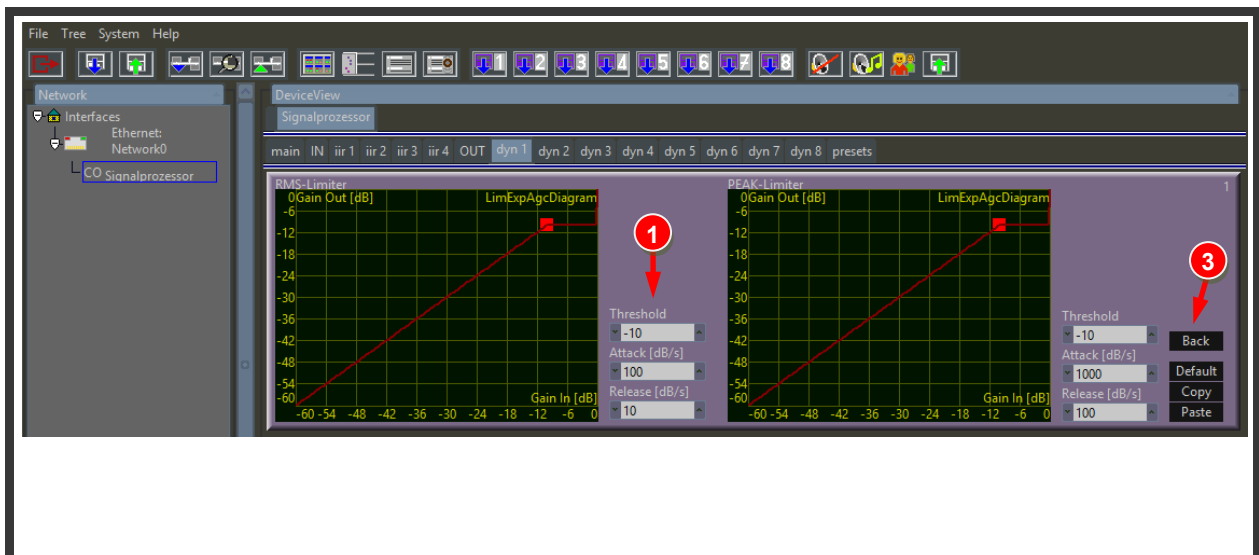

4.2.8 Presets Window

- (1) This is an overview of all available presets (24 in total). Presets 13-24 are typically the default presets and it is recommended to not overwrite them to always have a base preset for your system. Instead you should store your own user presets in the slots 1-12.
- (2) Here you can Load and store presets. To load a preset, select the preset number with the dropdown button and click “Load”. To store a preset, select the desired target preset number with the dropdown button, write in a preset name in the white text area and press “Store”.

 **Please note, that the white text area is not updated when loading a preset. It is only used to write in a preset name when storing a preset!**

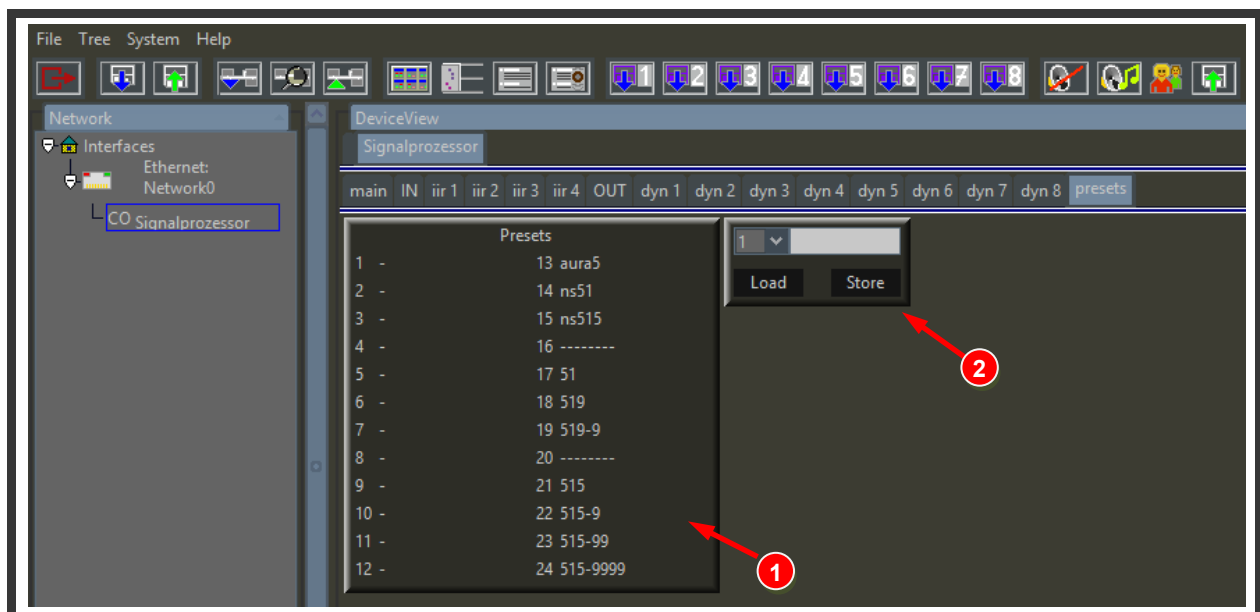

4.2.9 Loading and Saving Presets

It is possible the Load and Store presets to Windows files e.g. in order to make a backup of your settings.

(1) Right click with your mouse on “CO Signalprozessor” to open the menu. From here you can select “Save to Preset” to save your preset to a file or “Load from Preset” to load a preset from a file. “Disconnect” disconnects to unit and the “CO” in front of “Signalprozessor” will disappear.

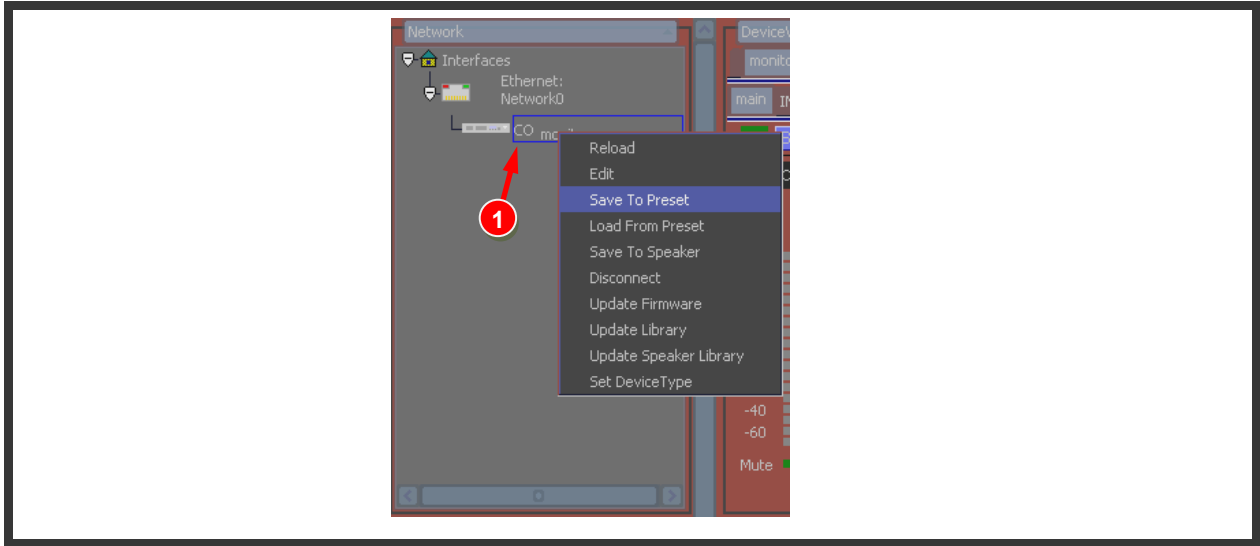

5. Specifications

Due to the nature of our speaker system we don't specify such kind as e.g. measured frequency response or maximum sound pressure, since our systems response is tuned to the room and adjusted to the listeners taste. Nonetheless we will provide specifications of our used amplifiers and the Signalprozessor.

5.1 Speaker Models

5.1.1 Dimensions and Weight

Modell 515

- Dimensions: W x H x L: 280mm x 480mm x 380mm
- Weight: ~ 21.5 kg

Modell 519

- Dimensions: W x H x L: 280mm x 550mm x 380mm
- Weight: ~ 26.5 kg

Modell 9

- Dimensions: W x H x L: 280mm x 280mm x 380mm
- Weight: ~ 16.5 kg

5.2 Amplification

5.2.1 Specifications

- 170W @ 4Ω, 1% THD+N, 20Hz – 20kHz
- 125dBA dynamic range
- THD+N = 0.002% @ 1W (8Ω, 1kHz, BTL)
- 81 % total efficiency @ 170W, 4Ω
- CCIF Intermodulation distortion = 0.0002%, 10W, 4Ω, 18.5kHz/1kHz
- Input voltage 85-132VAC or 170-264VAC
- Thermal protection
- Over current protection
- Sound optimized soft clipping
- EMI conforms to:

- EN55013
- EN55020
- EN61000-3-2
- EN61000-3-3
- FCC part 15-B
- Safety conforms to:
 - IEC 60065 7th ed.
 - UL 60065 7th ed.

The modules are protected against short-circuit, overload and over-heating and includes on-board fuses and EMI filtering to provide a CE and FCC pre-approved design.

5.3 Signalprozessor

5.3.1 Audio

- 4 analogue inputs
- 2 AES inputs, multiplexed with analogue inputs
- 8 analogue outputs
- AD: 120 dB SNR, -100 dB THD/N
- DA: 120 dB SNR, -104 dB THD/N
- Overall latency (in → out): ~2ms

5.3.2 DSP

- 96kHz high quality sampling
- 10 full parametric EQ's (IIR) per input channel
- Compressor and Limiter (RMS/Peak) per output channel
- 24 User-presets

5.3.3 Display

- graphical LCD-Display
- 7 multi function push keys
- 1 Encoder with push key
- level meter input channels (Limit, +-6dB, -12dB, -18dB, -24dB and Signal)
- level meter output channels (Limit, -3dB, -6dB, -12dB and Signal)

5.3.4 Network

- 10/100 Mbit Ethernet

5.3.5 Dimensions and Weight

- Dimensions: W x H x L: 483mm x 44mm x 210mm (19"/1HE)
- Weight: ~ 3,0 kg

Specifications are subject to change without prior notice.

6. Warranty

All suter/ohlhorst products are warranted to be free of manufacturing defects for a period of two years from the date of purchase to the original purchaser only. This warranty covers all parts and labor excluding shipping.

Failures due to accidental damage, being exposed to the elements, natural disaster are not covered by this warranty. If your unit needs service, please contact us for more information. All designed parts, layouts, drawings and all documentation copyrighted suter/ohlhorst (c) 2013-2016.

Any real or imagined damage due to the use of this product are the responsibility of the end user, not suter/ohlhorst. suter/ohlhorst retains the right to modify or improve this design without notification of any kind.

suter/ohlhorst
c/o Jan Ohlhorst
Breslauer Platz 4b
63755 Alzenau / Germany

phone: +49 172 6565509
info@suter-ohlhorst.com
VAT-ID: DE200206063
Jurisdiction: Alzenau / Germany